

## Manfrotto – adaptéry / redukce

All measurements shown are metric unless otherwise stated.

$\frac{1}{4}''$  Indicates an external thread or stud diameter  
● Metric ● Imperial

$\frac{1}{4}''$  Indicates an internal thread or socket diameter  
● Metric ● Imperial

**W:** Whitworth thread

### 16MM FEMALE ADAPTERS

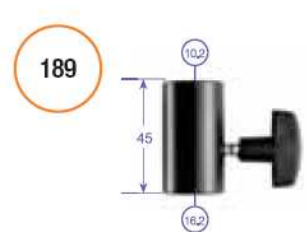
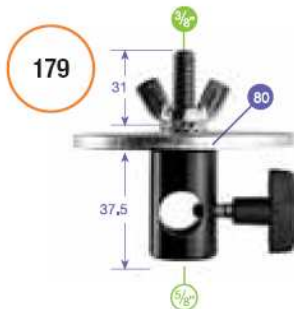
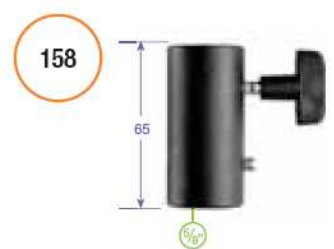
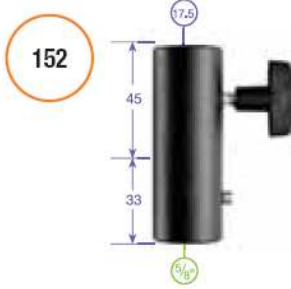
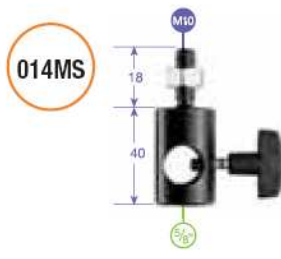
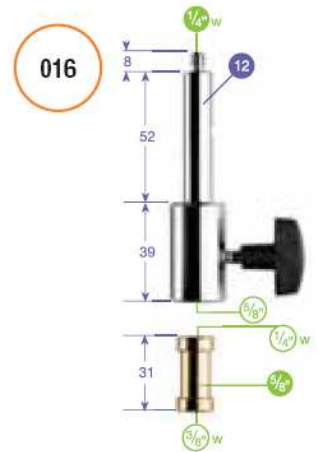
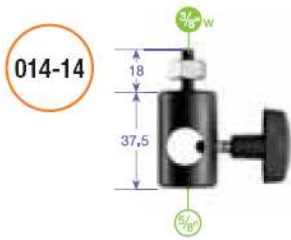

## 16MM MALE ADAPTERS

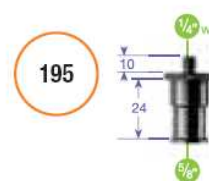
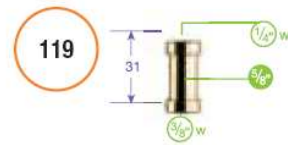
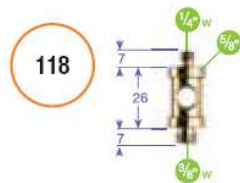

## 28MM MALE ADAPTERS

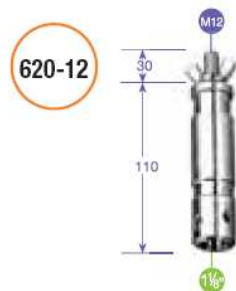
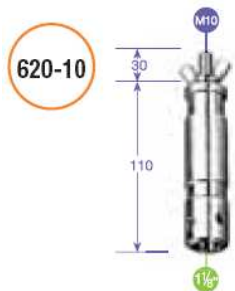
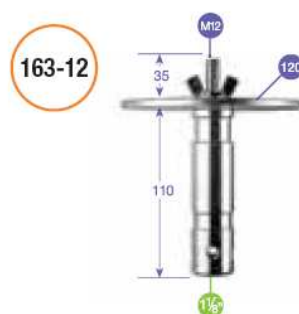

## SPECIAL ADAPTERS

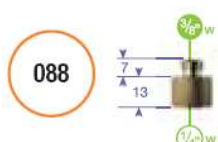

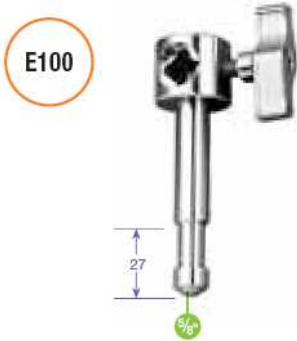

## SUPER CLAMP ADAPTERS

